

### VERSIONI FLANGIATE - FLANGED VERSION



**FR 35 F**



**FR 50 F**



**FR 55 F**

Modelli Models	Carico statico Static load	Carico dinamico Dynamic load	Peso Weight	Pressione Pressure	Rotazione Rotation	Coppia Torque	Portata Oil flow	D
	kg	kg	kg	bar		Nm	l/min	mm
FR 35 F	3500	1750	22	250	360° cont.	900	20	25
FR 50 F	5000	2500	28	250	360° cont.	1100	20	25
FR 50 F/30	5000	2500	28	250	360° cont.	1100	20	30
FR 55 F	5500	2700	33	250	360° cont.	1300	20	25
FR 55 F/30	5500	2700	33	250	360° cont.	1300	20	30

In conformità/According 2006/42/CE EN4413:2012 EN12100:2010

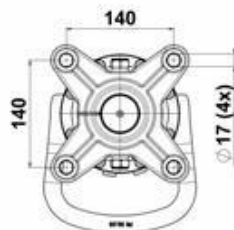
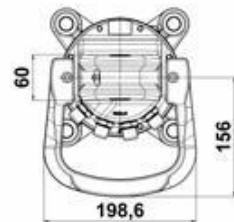
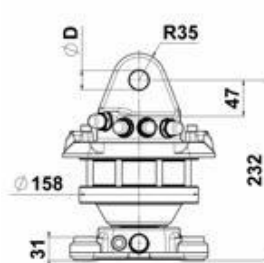

**FR 35 F**

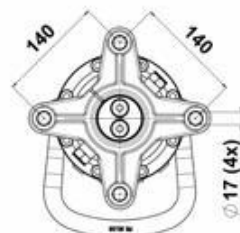
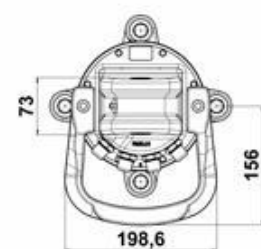
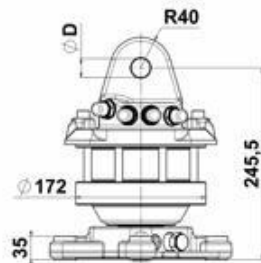

**FR 50 F**

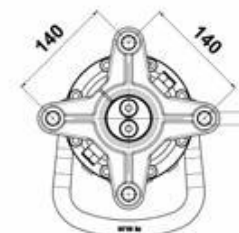
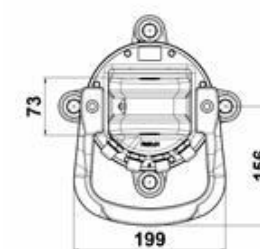
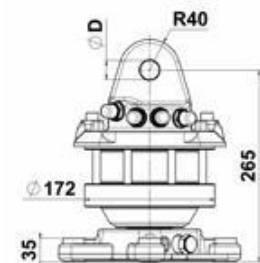

**FR 55 F**



## VERSIONI FLANGIATE - FLANGED VERSION



FR 85 SXF



FR 85 SXF/2



FR 128 SXF



FR 128 SXF/2

Modelli Models	Carico statico Static load	Carico dinamico Dinamic load	Peso Weight	Pressione Pressure	Rotazione Rotation	Coppia Torque	Portata Oil flow	D
	kg	kg	kg	bar		Nm	l/min	mm
FR 85 SXF	7000	3500	41	250	360° cont.	1900	25	35
FR 85 SXF/2	7000	3500	44	250	360° cont.	1900	25	35
FR 128 SXF	12000	6000	56	250	360° cont.	2700	30	35
FR 128 SXF/2	12000	6000	59	250	360° cont.	2700	30	35

In conformità/According 2006/42/CE EN4413:2012 EN12100:2010

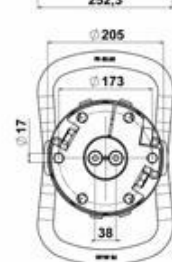
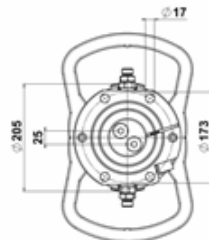
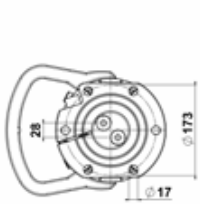
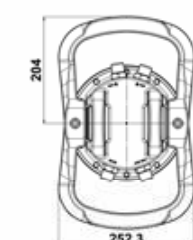
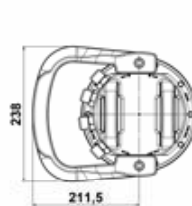
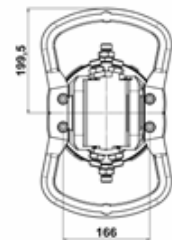
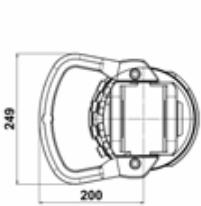
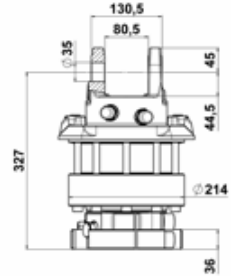
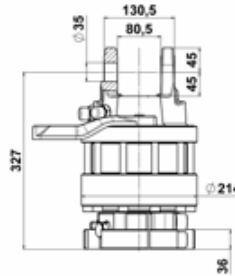
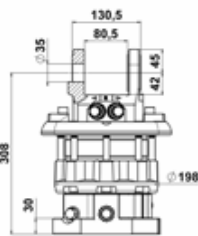
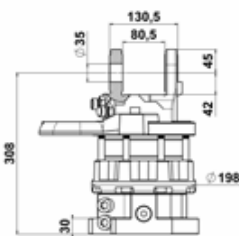

FR 85 SXF

FR 85 SXF/2

FR 128 SXF

FR 128 SXF/2

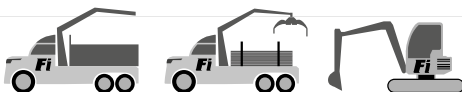

## VERSIONE FLANGIATA DOPPIA MANIGLIA - FLANGED VERSION DOUBLE HANDLE



FR 175 DBX-F/2

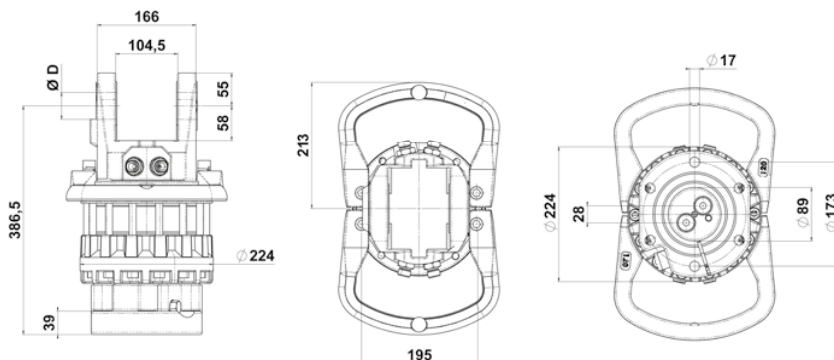

Modelli Models	Carico statico Static load	Carico dinamico Dynamic load	Peso Weight	Pressione Pressure	Rotazione Rotation	Coppia Torque	Portata Oil flow	D
	kg	kg	kg	bar		Nm	l/min	mm
FR 175 DBX-F/2	17000	8500	80	250	360° cont.	3600	30	45

In conformità/According 2006/42/CE EN4413:2012 EN12100:2010

## ROTATORE A PISTONI RADIALI - RADIAL PISTONS ROTATOR

Modelli Models	Carico statico Static load	Carico dinamico Dynamic load	Peso Weight	Pressione Pressure	Rotazione Rotation	Coppia Torque	Portata Oil flow
	kg	kg	kg	bar		Nm	l/min
FR 260 P	25000	8000	85	200	360° cont.	2000	25

In conformità/According 2006/42/CE EN4413:2012 EN12100:2010

