





 STABILIZZATORI SUPPLEMENTARI
 ADDITIONAL STABILIZER
 STABILISATEURS SUPPLEMENTAIRES
 ZUSATZABSTÜTZUNGEN

 ESTABILIZADORES ADICIONALES
 ДОПОЛНИТЕЛЬНЫЕ ОПОРЫ (АУТРИГЕРЫ)
 İLAVE DENGE AYAKLARI
 مشدات إضافية

HYDROLIFT™

BORN TO LIFT

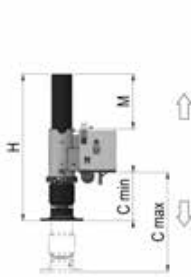
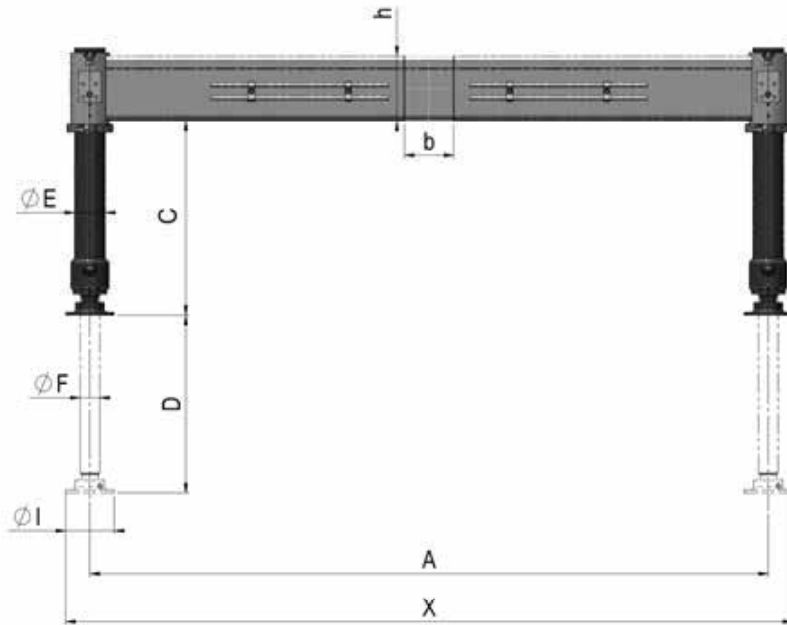

VERS: S

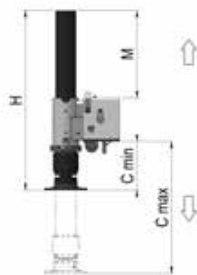

VERS: STANDARD

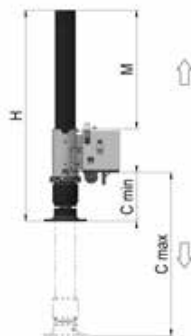



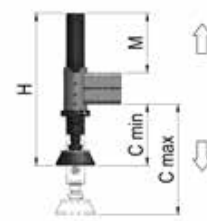

VERS: L

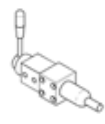

VERS: EVO 08 / EVO18

ACCESSORI / OPTION

1 - Piattello snodato di serie 1 - Swivel foot standard	2 - Fascia luminosa 2 - Led strip	3 - Distributore rotante 3 - Rotating distributor	4 - Prolunga stelo 4 - Rod extension
			 120 mm





STABILIZZATORI MECCANICI MECHANICAL STABILIZER







Tipo Type	Gru Crane	R. max	Peso Weight	A	B	X	hxb	C		I	D	E	F	H	M	Accessori Optional			
								Min	Max							1	2	3	4
EVO 08 2.6 M	2>6	1600	75	1600	2600	2750	120x80	220	400	150	330	70	40	540	200	•	○	○	○
EVO 08 2.6/L M	2>6	1600	79	1600	2600	2750	120x80	220	470	150	400	70	40	600	270	•	○	○	○
EVO 08 2.8 M	2>6	1600	79	1800	2800	2950	120x80	220	400	150	330	70	40	540	200	•	○	○	○
EVO 08 2.8/L M	2>6	1600	83	1800	2800	2950	120x80	220	470	150	400	70	40	600	270	•	○	○	○
EVO 18 3.3 M	6>12	3000	104	2090	3370	3520	140x90	220	470	150	400	70	40	600	280	•	○	○	○
EVO 28 3.3/L M	12>25	6300	186	2110	3310	3510	200x100	230	610	200	605	85	60	860	420	•	○	○	○
EVO 28 3.3 M	12>25	6300	178	2110	3310	3510	200x100	230	450	200	450	85	60	710	265	•	○	○	○
EVO 28 4.4/L M	12>25	6200	244	2120	4410	4610	200X200	230	610	200	605	85	60	860	425	•	○	○	○
EVO 28 4.4 M	12>25	6200	237	2120	4410	4610	200X200	230	450	200	450	85	60	710	270	•	○	○	○
EVO 38 3.3/L M	19>36	9000	225	2100	3300	3500	200x120	250	710	200	696	95	60	970	540	•	○	○	○
EVO 38 3.3 M	19>36	9000	218	2100	3300	3500	200x120	250	540	200	550	95	60	830	390	•	○	○	○
EVO 38 3.3/S M	19>36	9000	210	2100	3300	3500	200x120	250	440	200	400	95	60	680	240	•	○	○	○
EVO 38 4.7/L M	19>36	8600	350	2110	4710	4910	200X240	250	710	200	696	95	60	970	540	•	○	○	○
EVO 38 4.7 M	19>36	8600	340	2110	4710	4910	200X240	250	540	200	550	95	60	830	390	•	○	○	○
EVO 38 4.7/S M	19>36	8600	320	2110	4710	4910	200X240	250	440	200	400	95	60	680	240	•	○	○	○

○ A richiesta On request
 ● Standard Standard



Possibilità di fornire Kit predisposizione PLE vedi EN 12999-A2
 Possibility to provide PLE predisposition Kit according to EN 12999-A2

 STABILIZZATORI SUPPLEMENTARI
 ADDITIONAL STABILIZER
 STABILISATEURS SUPPLEMENTAIRES
 ZUSATZABSTÜTZUNGEN

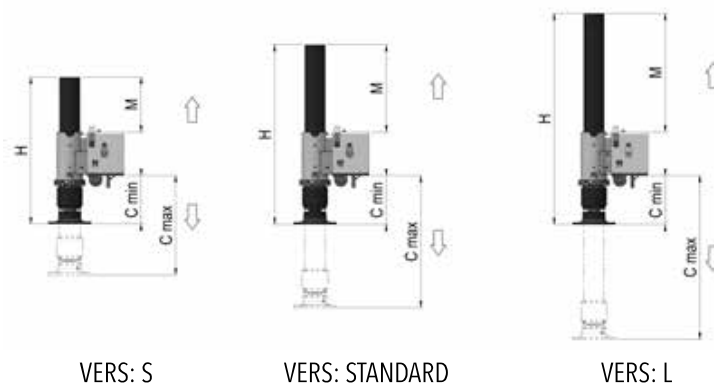
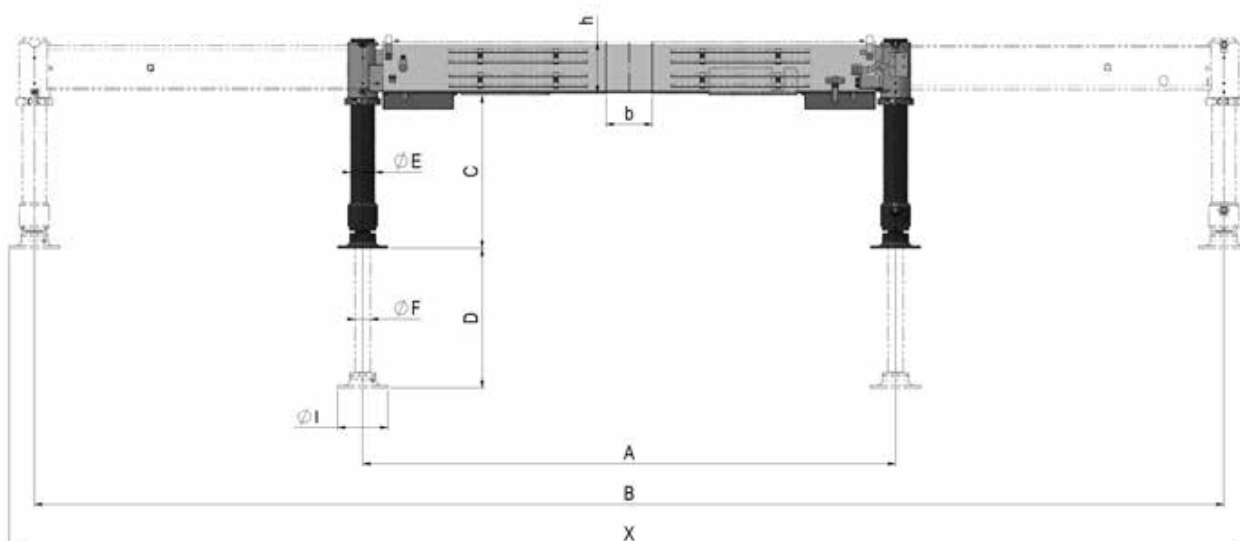
 ESTABILIZADORES ADICIONALES
 ДОПОЛНИТЕЛЬНЫЕ ОПОРЫ (АУТРИГЕРЫ)
 İLAVE DENGE AYAKLARI
 مَشْتَاتات إضافية

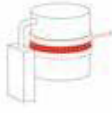
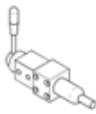

ACCESSORI / OPTION

1 - Piattello snodato di serie 1 - Swivel foot standard	2 - Fascia luminosa 2 - Led strip	3 - Distributore rotante 3 - Rotating distributor	4 - Prolunga stelo 4 - Rod extension
			 120 mm





STABILIZZATORI IDRAULICI HYDRAULIC STABILIZER







Tipo Type	Gru Crane	R. max	Peso Weight	A	B	X	hxb	G	C		I	D	E	F	H	M	Accessori Optional			
									Min	Max							1	2	3	4
EVO 28 3.3/L H	12>25	6300	209	2110	3310	3510	200x100	-	200	610	200	605	85	60	860	420	•	○	○	○
EVO 28 3.3 H	12>25	6300	199	2110	3310	3510	200X100	-	200	450	200	450	85	60	710	265	•	○	○	○
EVO 28 4.4/L H	12>25	6200	287	2120	4410	4610	200X200	-	200	610	200	605	85	60	860	425	•	○	○	○
EVO 28 4.4 H	12>25	6200	281	2120	4410	4610	200X200	-	200	450	200	450	85	60	710	270	•	○	○	○
EVO 38 3.3/L H	19>36	9000	283	2100	3300	3500	200X120	-	235	710	200	650	95	60	970	540	•	○	○	○
EVO 38 3.3 H	19>36	9000	255	2100	3300	3500	200X120	-	235	540	200	500	95	60	830	390	•	○	○	○
EVO 38 3.3/S H	19>36	9000	227	2100	3300	3500	200X120	-	235	440	200	400	95	60	680	240	•	○	○	○
EVO 38 4.7/L H	19>36	8600	350	2110	4710	4910	200X240	-	235	710	200	650	95	60	970	540	•	○	○	○
EVO 38 4.7 H	19>36	8600	340	2110	4710	4910	200X240	-	235	540	200	500	95	60	830	390	•	○	○	○
EVO 38 4.7/S H	19>36	8600	330	2110	4710	4910	200X240	-	235	440	200	400	95	60	680	240	•	○	○	○
EVO 48 5.0/L H	25>40	10500	425	2200	5000	5200	250X240	-	235	660	200	650	95	60	970	520	•	○	○	○
EVO 48 5.0 H	25>40	10500	416	2200	5000	5200	250X240	-	235	500	200	500	95	60	830	370	•	○	○	○
EVO 48 5.0/S H	25>40	10500	407	2200	5000	5200	250X240	-	235	390	200	400	95	60	680	220	•	○	○	○
EVO 68 5.0 H	40>60	14000	520	2200	5000	5200	300x240	-	230	615	200	650	105	70	930	400	•	○	○	○
EVO 68 5.0/S H	40>60	14000	526	2200	5000	5200	300x240	-	230	440	200	500	105	70	780	250	•	○	○	○
EVO 88 6.0 H	50>80	17000	883	2290	6000	6200	320x320	510	145	540	200	600	125	90	900	435	•	○	○	○
EVO 88 6.0/S H	50>80	17000	863	2290	6000	6200	320x320	510	145	370	200	440	125	90	750	300	•	○	○	○
EVO 108 6.9 H	70>100	18000	955	2315	6900	7100	320x360	525	70	450	200	600	125	90	900	490	•	○	○	○
EVO 108 6.9/S H	70>100	18000	935	2315	6900	7100	320x360	525	70	295	200	440	125	90	750	360	•	○	○	○

○ A richiesta On request
 ● Standard Standard

Possibilità di fornire Kit predisposizione PLE vedi EN 12999-A2
 Possibility to provide PLE predisposition Kit according to EN 12999-A2

 STABILIZZATORI SUPPLEMENTARI
 ADDITIONAL STABILIZER
 STABILISATEURS SUPPLEMENTAIRES
 ZUSATZABSTÜTZUNGEN

 ESTABILIZADORES ADICIONALES
 ДОПОЛНИТЕЛЬНЫЕ ОПОРЫ (АУТРИГЕРЫ)
 İLAVE DENGE AYAKLARI
 مثبتات إضافية

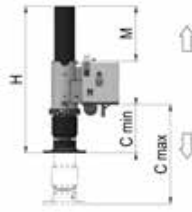
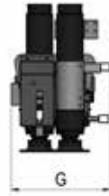
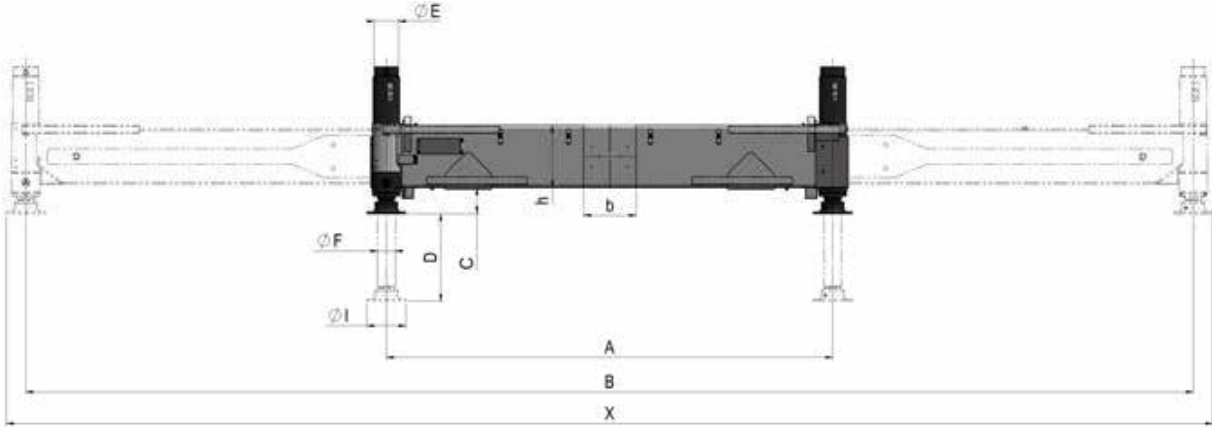

VERS: S

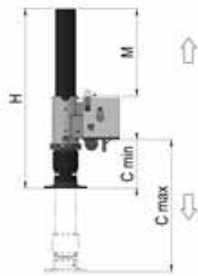

VERS: STANDARD

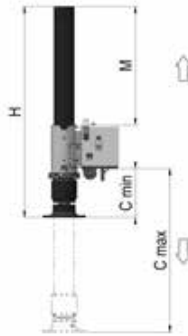

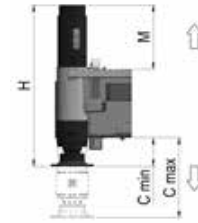

VERS: L

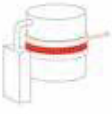
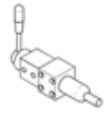

VERS: EVO 88-108

ACCESSORI / OPTION

1 - Piattello snodato di serie 1 - Swivel foot standard	2 - Fascia luminosa 2 - Led strip	3 - Distributore rotante 3 - Rotating distributor	4 - Prolunga stelo 4 - Rod extension
			 120 mm